

SPHERE 800D

LED MIRROR

SPECIFICATIONS

WIDTH	810mm
HEIGHT	810mm
DEPTH	40mm
WEIGHT	12kg

LIGHTING SPECIFICATIONS

CCT	2700K - 6500K
CRI	>80

INSTALLATION

Wall mount
Hardwire
Input voltage: 220-240v 50Hz

FEATURES

Copper Free Mirror
LED Lighting (Adjustable Colour Temperature)
Frontlit
Touch Sensor
Demister with 1 Hour Auto Cut-off
Coloured Aluminium Frame

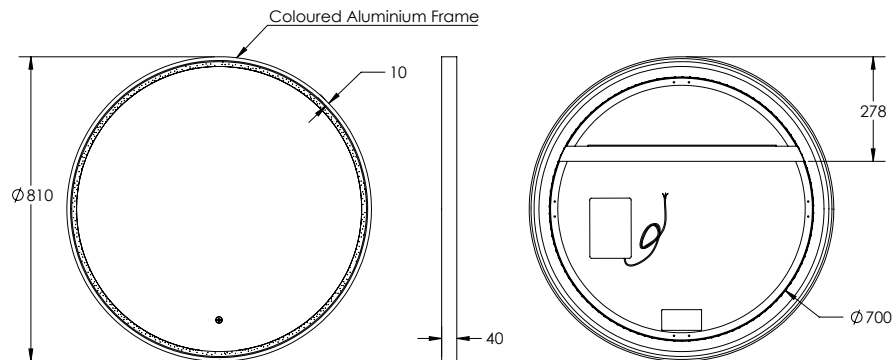

FINISHES

PRODUCT CODE

Matt Black



S80D-MB

Gun Metal



S80D-GM

Brushed Nickel



S80D-BN

Rose Gold



S80D-RG

Brushed Brass



S80D-BB



Disclaimer: All LED Products requiring hardwiring must be installed by a licensed electrician in accordance with local regulations. Sizes are in mm and nominal and should be checked prior to installation. Actual colours may vary so please check colour samples before ordering. Installation is acceptance of our products. Installation of faulty, warped, chipped or damaged products will void our warranty.