

Thermonet 150W/m² T Kits

For Installation Under Tile & Stone Floors

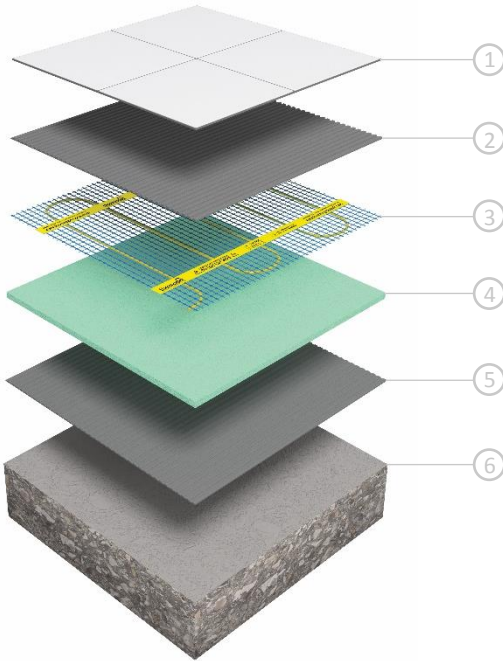

1. Tiled floor finish
2. Flexible tile adhesive
3. Thermonet 150W/m² heating mat
4. Econoboard uncoated insulation board
5. Flexible tile adhesive
6. Concrete substrate



Lifetime Warranty

We are so confident of the quality of our German-made Thermonet Underfloor Heating that we give each system a warranty that lasts a Lifetime with 3 year warranty on our Thermostats.



TwistedTwin cable construction

The unique stress free cable construction creates a longer lasting heating cable with zero electromagnetic field (Zero EMF).



Full self adhesive mesh

The self adhesive mesh speeds up installation by holding Thermonet matting to the substrate for easy self levelling and tile fixing.



Heating cable protection

Thermonet is installed wire-side-down which means the heating cable is protected from damage during installation by the hard wearing mesh layer.



Minimal Height Build-up

Utilising innovative extrusion processes provides real 'lay flat' technology that makes installing Thermonet easy. The matting system is only 3.5mm thick with a low profile cold tail of only 4mm thick which is typically concealed within the tile adhesive layer.

Technical Data



Kit Includes: Thermonet 150W/m² Mat, Programmable Thermostat (5220A), Floor Temperature Sensor, Sensor Conduit, Cable Monitor, Installation Guide & Warranty Form.

Width	500mm
Heated Width	430mm
Thickness	3.5mm
Max. Temperature	28°C *
Protection Rating	IP68
Warranty	Lifetime on heating mat
Wattage	150W/m ²
Conductor Type	Single Ended
Cold Tail Length	5m

*Regulated by floor sensing thermostat



Installation Overview

Thermonet electric underfloor heating mat is quick and easy to install. This overview gives a guide to the basics. Always read the instructions in full before attempting your own installation.

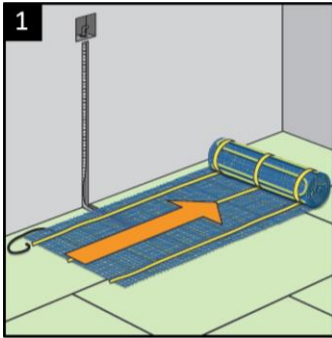

1 Roll out the mesh
The mesh should be laid wire side down

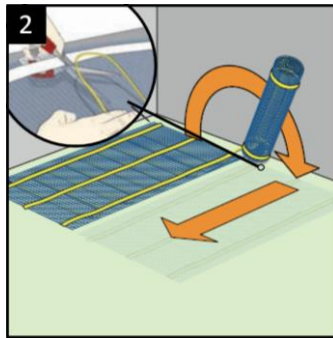

2 Cut the mesh (not the cable)
Turn the mesh 180° and continue rolling

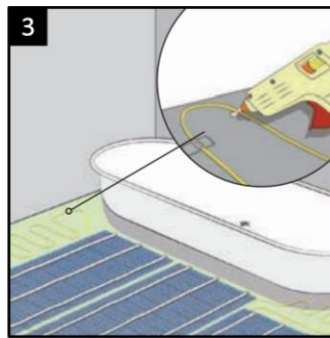

3 Loose run for irregular areas
Remove the cable from the mesh, arrange and stick down

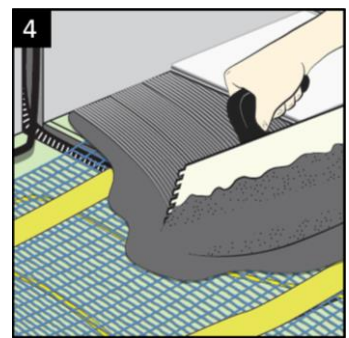

4 Laying the tiles
Use a flexible tile adhesive to fix tiles straight over the heating

This is an illustrative guide only. Read the instruction manual that is supplied with the system in full before attempting installation.

Thermonet Mesh 150W/m² T Kits

Stock Code	Size (m)	Area (m ²)	Output (W)	Resistance (Ω)
111502T	2 x 0.5	1.0	150	353
111503T	3 x 0.5	1.5	225	235
111504T	4 x 0.5	2.0	300	176
111505T	5 x 0.5	2.5	375	141
111506T	6 x 0.5	3.0	450	118
111507T	7 x 0.5	3.5	525	101
111508T	8 x 0.5	4.0	600	88
111509T	9 x 0.5	4.5	675	78
111510T	10 x 0.5	5.0	750	71
111512T	12 x 0.5	6.0	900	59
111514T	14 x 0.5	7.0	1050	50
111516T	16 x 0.5	8.0	1200	44
111518T	18 x 0.5	9.0	1350	39
111520T	20 x 0.5	10.0	1500	35
111524T	24 x 0.5	12.0	1800	29
111528T	28 x 0.5	14.0	2100	25
111532T	32 x 0.5	16.0	2400	22





Thermotouch 7.6iG thermostat features a sleek white glass display and an improved 7 day 6 event heating schedule

Easily program 6 heating events (3 on and 3 off) for every day of the week to create an efficient, automatic schedule for your electric underfloor heating system

- 

Designed to control your electric underfloor heating system easily and automatically
- 

Built in ambient temperature sensor and external floor sensor for accurate temperature management
- 

Lock the screen to prevent tampering by holding the up and down arrows for 5 seconds
- 

Design an economical heating schedule for your underfloor heating system that fits your lifestyle
- 

Adjust the temperature manually to boost your underfloor heating until the next scheduled heating event

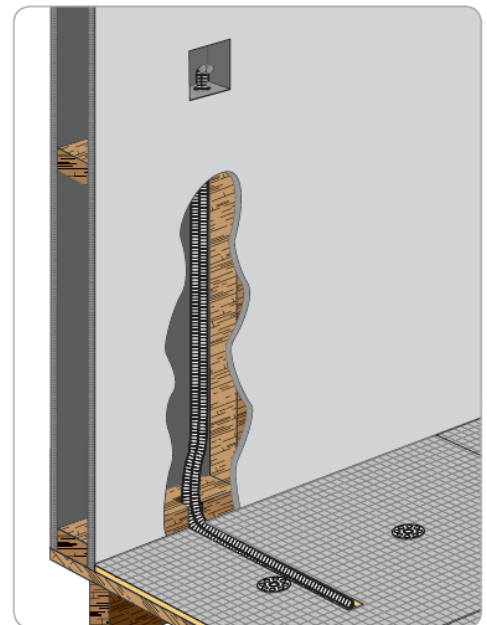

Floor temperature sensor should be installed in a conduit, within a clear area of the floor, and away from any other temperature influences.

Wiring diagram

1. Live – 240V supply
2. Neutral – 240V supply
3. Neutral – Underfloor heating
4. Live – Underfloor heating
5. Earth
6. Floor sensor (not polarity sensitive)
7. Floor sensor (not polarity sensitive)

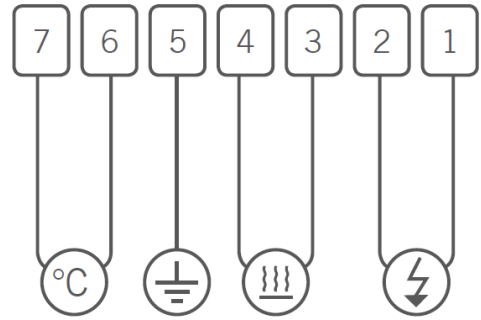

Box contents

- 1 x Thermotouch 7.6iG
- 1 x Installation guide
- 1 x 3m floor temperature sensor probe
- 1 x 2m sensor conduit
- 2 x Fixing screws
- 1 x Portrait mounting plate

Dimensions (mm)

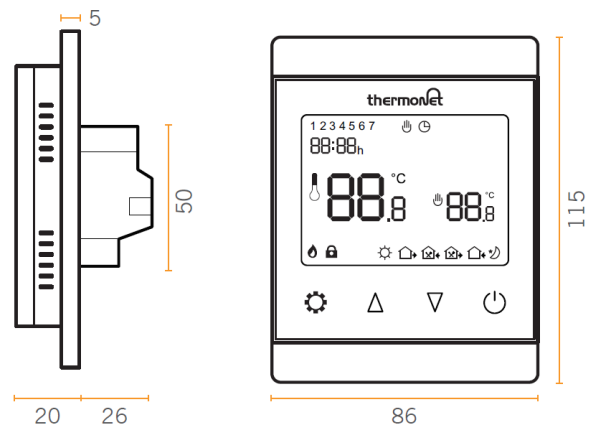

Technical data

Supply voltage	240V 50/60Hz
Maximum load	16A (3600W)
Backup storage	EEPROM (approx. 1 year backup)
Temperature range	5 ~ 80°C (0.5°C increments)
Accuracy	± 0.5°C
Sensor rating	NTC 10Ω @ 25°C
Consumption	2W
Warranty	3 year
IP rating	IP30
Width	86mm
Height	115mm
Depth	46mm (26mm in wall)